



leitz

Solutions
in New
Dimensions

Leitz GmbH & Co. KG

Fiber cement – tools and processing
solutions for experts

Martin Heckel – Head of Product Management

Leitz GmbH & Co. KG

Mission statement



Focus on our customers!

Our customers have the ideas –
we have the tools and the know-how to achieve them.

This makes us the worldwide solution partner in the processing of wood, wood derived materials and advanced materials such as fiber cement, insulating materials, composite materials and NF metals.



Leitz GmbH & Co. KG

General information



- Fifth generation family enterprise
- 3.000 employees
- 8.000 standard tools
- Export quota approx. 75 %
- Sales distribution: 70 % new tooling
30 % service



Leitz GmbH & Co. KG

International locations



- 7 production plants in Europe, Asia and America
- Sales companies in 38 countries



Leitz GmbH & Co. KG

Service locations



- Over 100 service stations, worldwide



Leitz GmbH & Co. KG

Our markets



Timber construction

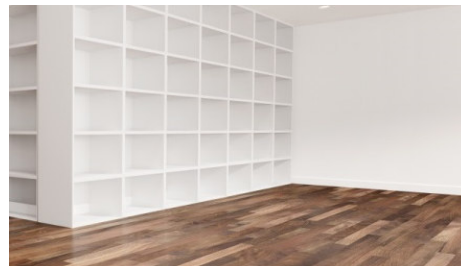

Flooring



Furniture production
and panels



Windows, doors
and stairs



Power tools

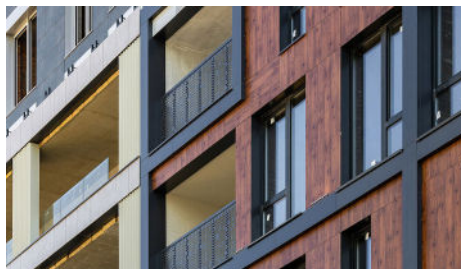

Facades and
insulating materials



Processing of
non-ferrous metals



Plastics and
composite materials

Leitz - tools and processing solutions for experts

Global networking



Machine tool
builders



Powertools



Producers



Shop floors

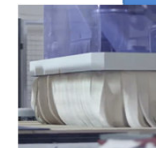

Leitz - tools and processing solutions for experts

Solutions for all process steps



Wet
machining

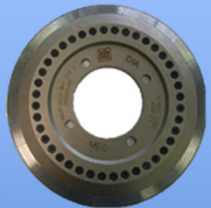

Cutting
Profiling

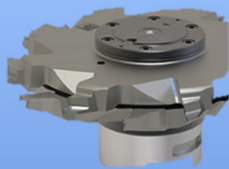

Clamping
systems



CNC
machining



Dust
extraction

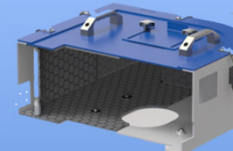

Service/
After Sales



Power
tools



Leitz - tools and processing solutions for experts

Solutions for all process steps



Wet
machining



Cutting/
Profiling



Clamping
systems



CNC
machining



Dust
doods

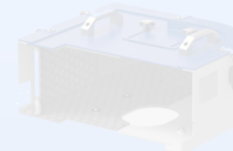

Service



Power
tools



Leitz - tools and processing solutions for experts



Wet machining

Diamaster EvolutionCut Circular Knife

Diamond-tipped circular knives from Leitz help manufacturers to save time and money.

EvolutionCut ensures long system lifetimes at high feed rates and this with consistently perfect machining quality.



Leitz - tools and processing solutions for experts



Wet machining

YOUR BENEFITS

- Long lifetime
- Less machine downtime
- Less processing costs
- Perfect cutting quality
- High machining security

AT A GLANCE

- Resharpenable 8 times
- Tool set with pressure shoe and flange
- Replaceable wear parts for the pressure shoe
- Diamond cutting material



Leitz - tools and processing solutions for experts

Solutions for all process steps



Wet
machining

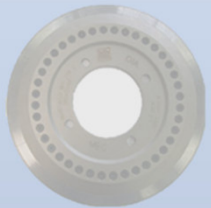

Cutting
Profiling

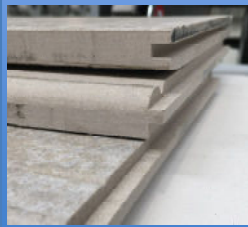
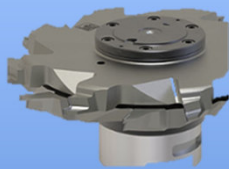

Clamping
systems



CNC
machining



Dust
doods



Service



Power
tools



Leitz - tools and processing solutions for experts

Cutting / Profiling



Economical processes through optimised tool solutions for profiling on double-end profiler

YOUR BENEFITS

- Individual coordination of tool solutions in the overall process
- Less tool costs
- Long lifetime of the tools
- Best quality

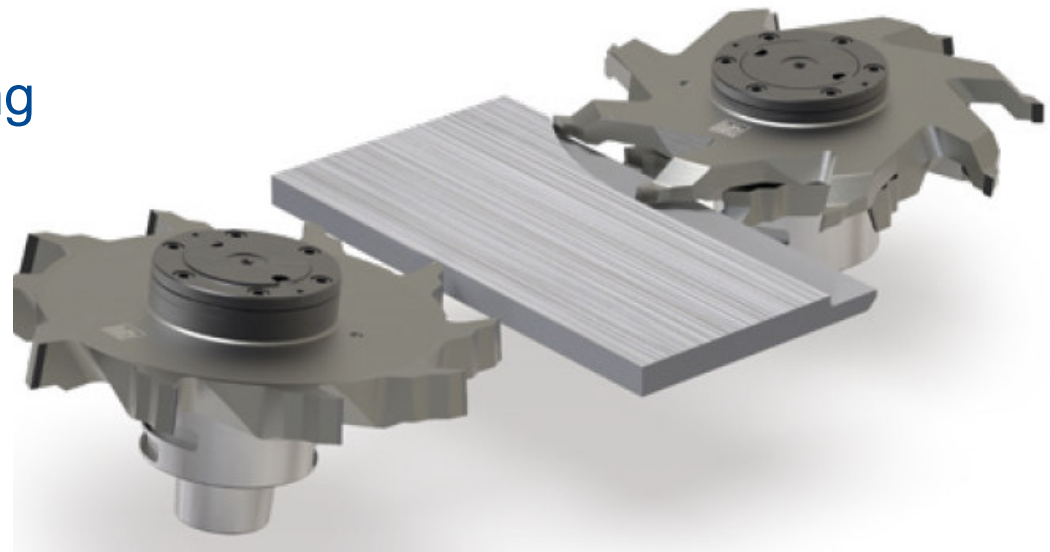

DP tipped profil cutter on closed HSK-85 S hydro sleeves for DET machines

Leitz - tools and processing solutions for experts

Cutting / Profiling



Individual tool combinations
optimally coordinated

YOUR BENEFITS

- Lasting savings opportunities through efficient tool combinations
- Optimum resource planning
- Energy-saving tool and process concepts
- Sustainable process design



Multi Rip Spindle

Top spindle: DP-V groove cutters on
closed hydro sleeves

Bottom spindle: splitting

Leitz - tools and processing solutions for experts

Solutions for all process steps



Wet
machining

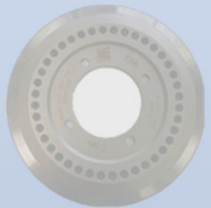

Cutting/
Profiling

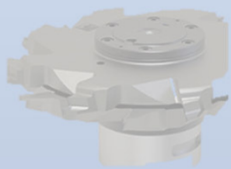

Clamping
systems



CNC
machining



Dust
extraction

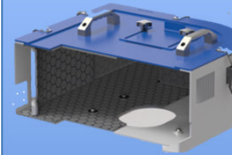

Service



Power
tools



Leitz - tools and processing solutions for experts

Dust hoods with DFC - Dust Flow Control

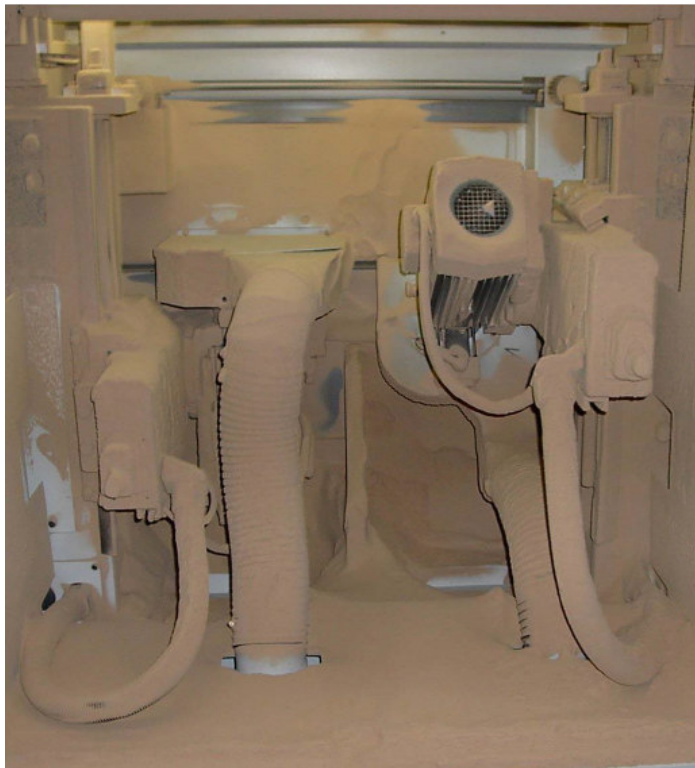

Leitz - tools and processing solutions for experts

Dust hoods with DFC - Dust Flow Control

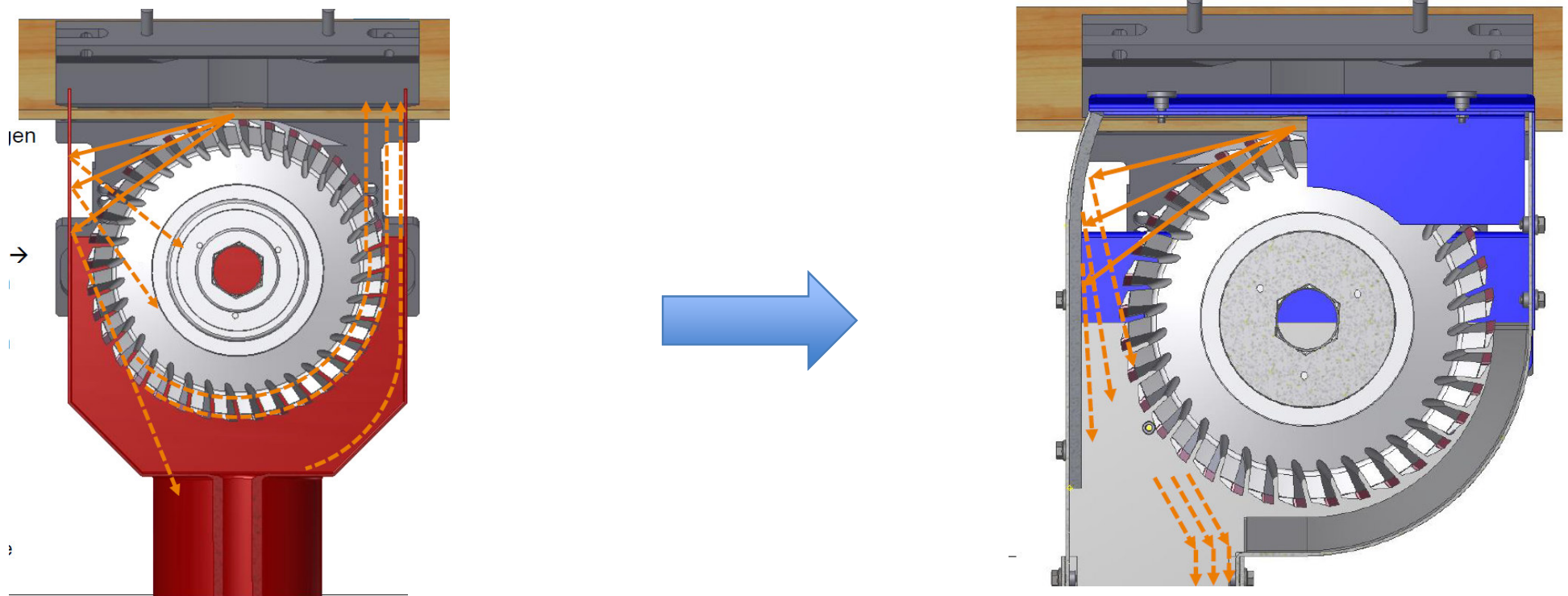

Leitz - tools and processing solutions for experts



Dust hoods with DFC - Dust Flow Control

More quality, cost-effectiveness, and safety through efficient chip collection: DFC®-Extraction hoods with ceramic wear protection

YOUR BENEFITS

- Individual design and adaptation
- Optimum matching to profile, material thickness and machining
- Less wear on the tool
- Long durability due to ceramic armouring

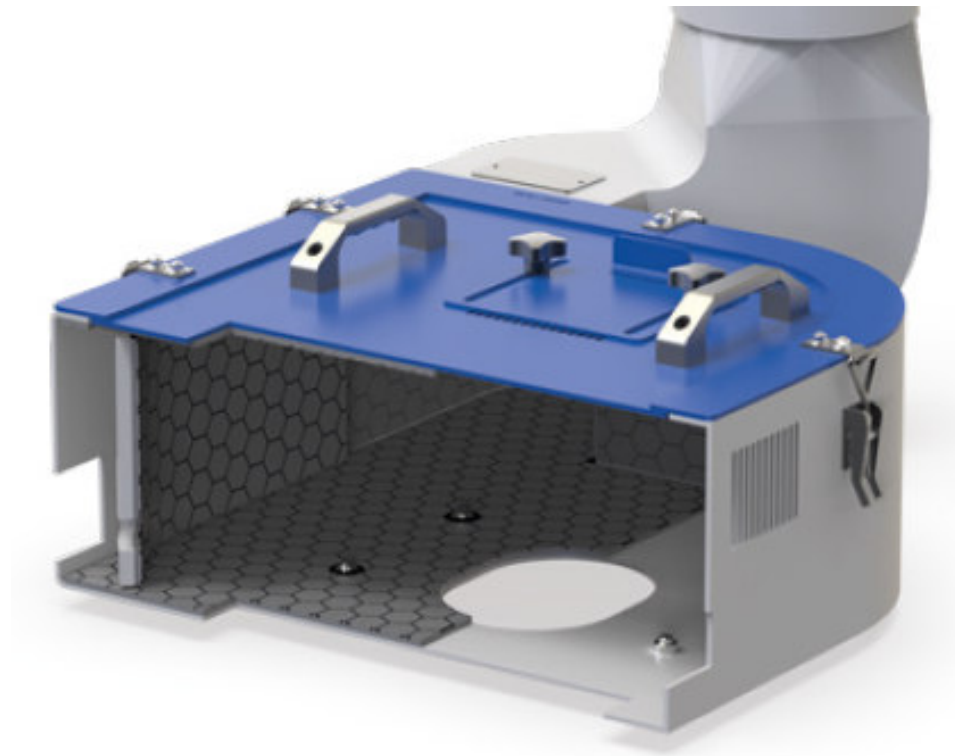

Leitz - tools and processing solutions for experts

Solutions for all process steps



Wet
machining

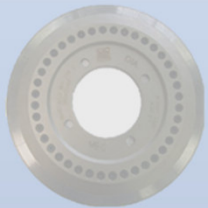

Cutting/
Profiling

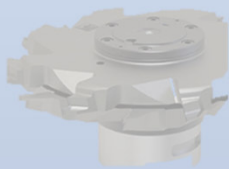

Clamping
systems



CNC
machining



Dust
doods

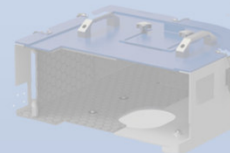

Service



Power
tools



Leitz - tools and processing solutions for experts

Service



Leitz Service – worldwide

Leitz offers tool reconditioning in manufacturer-quality through its unique service network in all relevant markets.

Everything is possible, from invoicing per regrinding up to a Complete Care package.



Leitz - tools and processing solutions for experts

Leitz Competence for professional machining



- Worldwide competence in the processing of fibre cement
- Comprehensive Leitz product portfolio
- DFC - specially developed extraction hoods for the respective processing situation
- Tool service in manufacturer quality. Through the worldwide Leitz service network

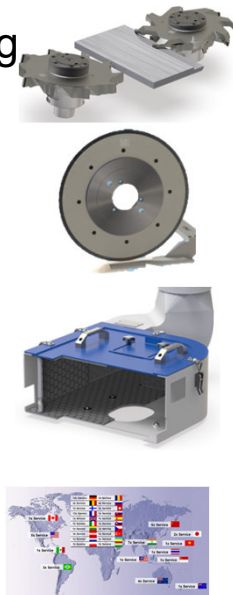

Leitz - tools and processing solutions for experts



Contact

Martin Heckel

Head of Product- and Industry Management

Leitz GmbH & Co. KG

Leitzstrasse 2

73447 Oberkochen, Germany

Tel. +49 7364 950-238

Mobile +49 160 94953154

E-Mail: mheckel@leitz.org

URL: www.leitz.org



The image shows a multi-page brochure for Leitz fibre cement processing solutions. The top page features the Leitz logo and the title 'Product information Fibre cement - Tool and processing solutions for experts'. It includes a photograph of a modern building and text describing the benefits of fibre cement, such as 'More productivity, quality and sustainability in the production process'. A second page shows a blue and white machine used for processing fibre cement, with text stating 'Economical processes through optimised tool solutions for profiling on throughfeed machines'. A third page features a circular tool, the 'Diamaster EvolutionCut Circular Knife', with a list of benefits: 'Long lifetime', 'Less machine downtime', 'Less processing costs', 'Perfect cutting quality', 'High tool-changing security', 'Fishergarable 8 times', 'Cut with pressure shoe and Bege', 'Replaceable wear parts for the pressure shoe', and 'Diamond cutting material'. The bottom page shows a close-up of a tool with a diamond cutting edge and text: 'Energy-saving tool and process concepts' and 'Sustainable process design'. The Leitz logo and contact information are visible at the bottom of the brochure.